

**Tower Crane
Grue à tour**

Turmdrehkran 35 K

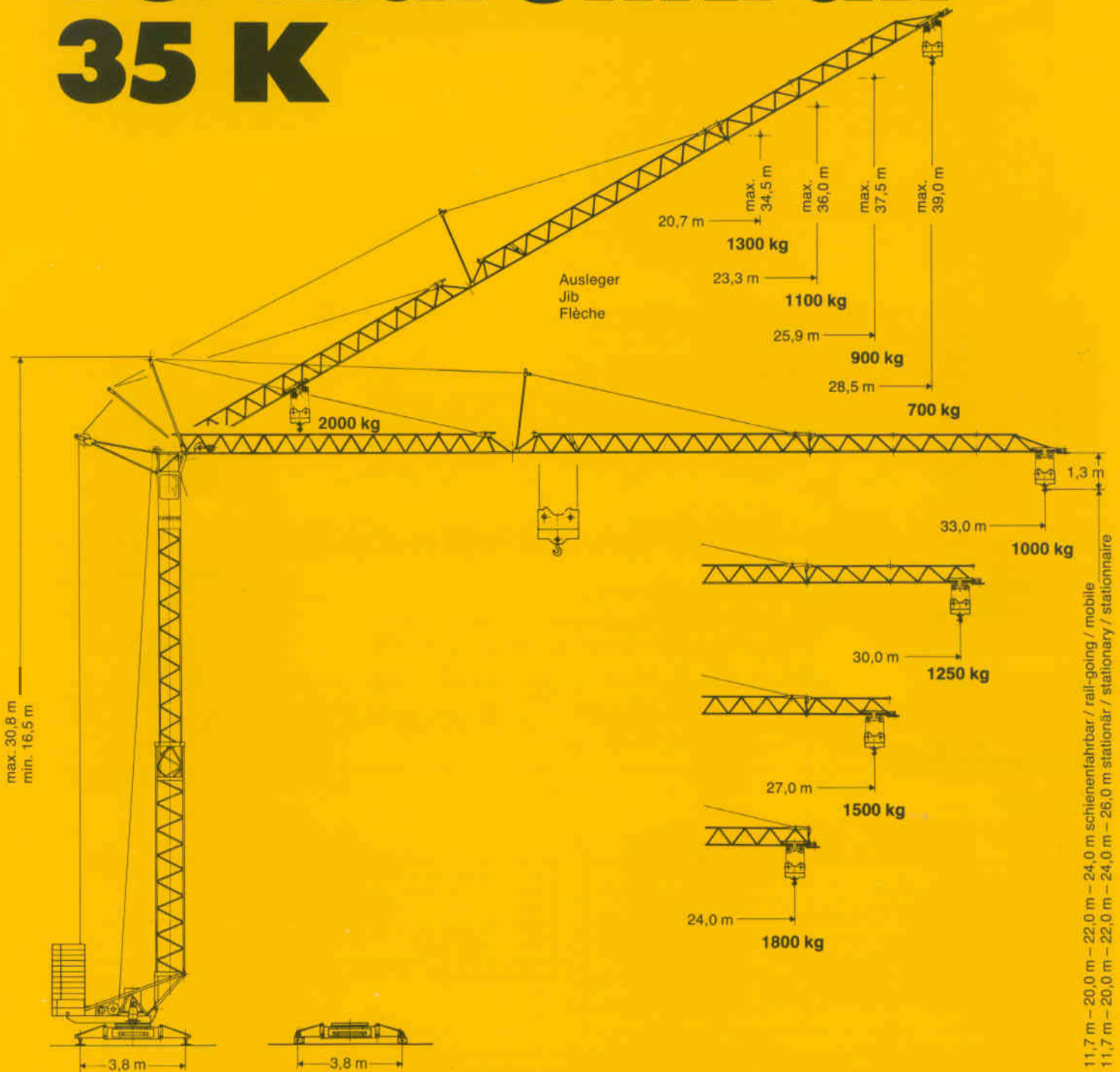

LIEBHERR

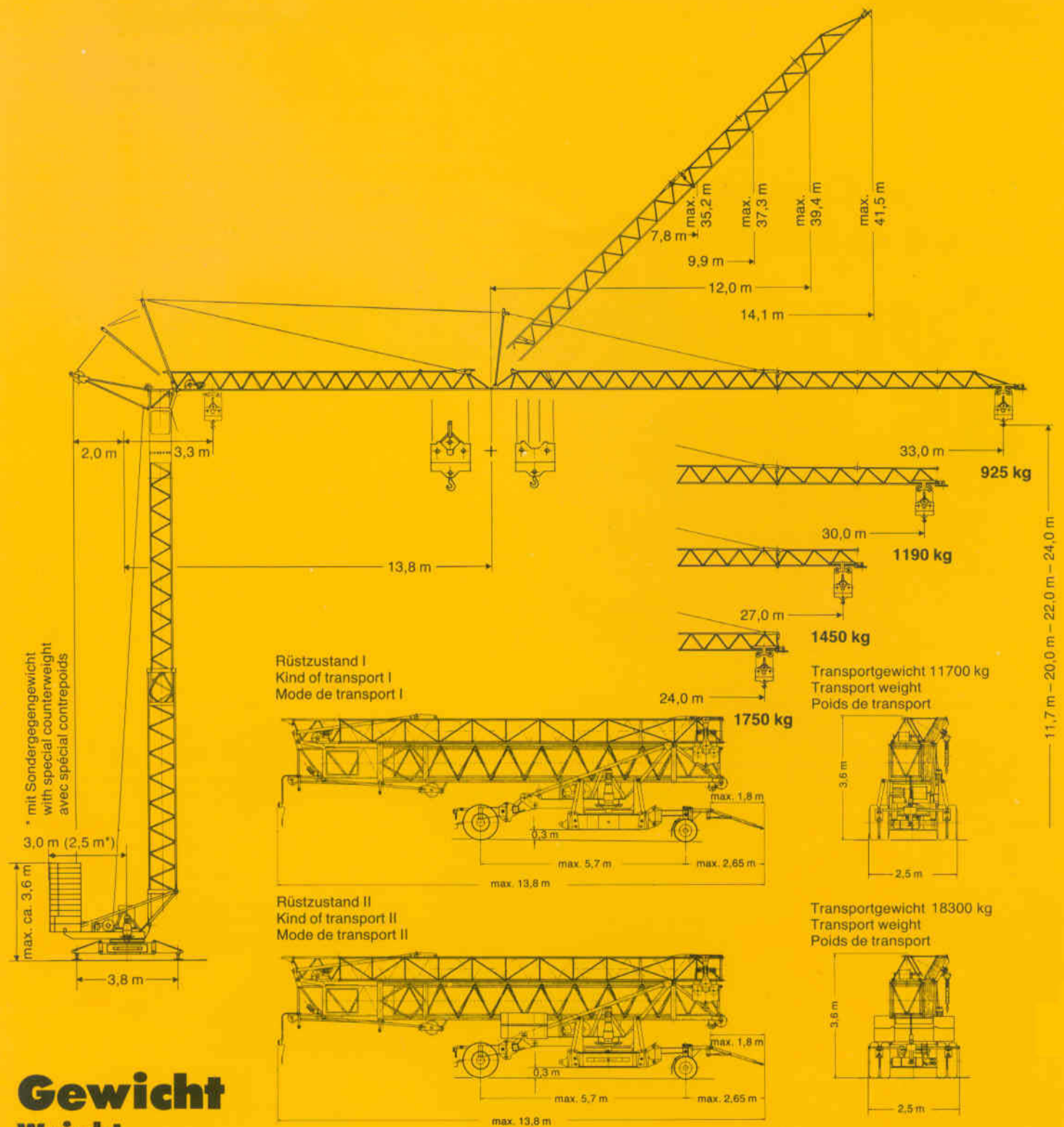

Gewicht Weight Poids

Max. Eckkraft in Betrieb Max. corner pressure in operation Réaction maxi. par angle en service	185 kN*
Zentralballast Central ballast weight Lest de base	1400 kg
Gegengewicht Counterweight Contrepoids	17060 kg





Max. Eckkraft außer Betrieb Max. corner pressure out of operation Réaction maxi. par angle hors service	113 kN*
Konstruktionsgewicht ca. Dead weight approx. Poids de la construction env.	10800 kg





* Umrechnung der Einheiten für Kräfte 1 kp = 10 N; 10 kN = 1 Mp. / Conversion of the units for forces. / Conversion des unités des forces.





35 K

Ausladung und Tragfähigkeit



Radius and capacity / Portée et charge

Auslegerlänge Length of jib Longueur de flèche m	Max. Tragfähigkeit Max. capacity Charge maxi. m/kg		Ausladung und Tragfähigkeit Radius and capacity Portée et charge m/kg																						
			12,0	13,0	14,0	15,0	16,0	17,0	18,0	19,0	20,0	21,0	22,0	23,0	24,0	25,0	26,0	27,0	28,0	29,0	30,0	31,0	32,0	33,0	
33,0	3,3 – 18,5 2000		2000	2000	2000	2000	2000	2000	2000	2000	1945	1830	1725	1630	1545	1470	1400	1335	1275	1220	1170	1125	1080	1035	1000
30,0	3,3 – 20,6 2000		2000	2000	2000	2000	2000	2000	2000	2000	2000	2000	1950	1840	1745	1655	1570	1495	1425	1365	1305	1250			
27,0	3,3 – 21,4 2000		2000	2000	2000	2000	2000	2000	2000	2000	2000	2000	2000	1930	1830	1735	1650	1570	1500						
24,0	3,3 – 21,9 2000		2000	2000	2000	2000	2000	2000	2000	2000	2000	2000	2000	2000	1900	1800									

Auslegerlänge Length of jib Longueur de flèche m	Max. Tragfähigkeit Max. capacity Charge maxi. m/kg		Ausladung und Tragfähigkeit Radius and capacity Portée et charge m/kg																					
			12,0	13,0	14,0	15,0	16,0	17,0	18,0	19,0	20,0	21,0	22,0	23,0	24,0	25,0	26,0	27,0	28,0	29,0	30,0	31,0	32,0	33,0
33,0	3,3 – 11,4 3500		3300	2980	2715	2495	2300	2135	1990	1860	1745	1640	1550	1465	1390	1320	1255	1200	1145	1095	1045	1005	960	925
30,0	3,3 – 12,6 3500		3500	3380	3080	2830	2610	2420	2255	2110	1980	1865	1760	1665	1580	1500	1425	1360	1300	1240	1190			
27,0	3,3 – 13,2 3500		3500	3500	3265	3000	2770	2570	2395	2240	2100	1980	1870	1770	1680	1595	1520	1450						
24,0	3,3 – 13,6 3500		3500	3500	3395	3120	2880	2670	2490	2330	2190	2060	1950	1845	1750									

Auslegerlänge Length of jib Longueur de flèche m	Max. Tragfähigkeit Max. capacity Charge maxi. m/kg		Ausladung und Tragfähigkeit Radius and capacity Portée et charge m/kg																	Auslegerstellung 30° Elevated jib 30° Flèche inclinée 30°				
			10,4	11,3	12,1	13,0	13,9	14,7	15,6	16,5	17,4	18,3	19,1	20,0	20,7	21,7	22,5	23,3	24,7	25,9	27,2	28,5		
33,0	3,1 – 12,4 2000		2000	2000	2000	1875	1730	1605	1495	1400	1315	1235	1170	1105	1050	995	950	905	845	790	745	700		
30,0	3,1 – 13,6 2000		2000	2000	2000	2000	1945	1805	1685	1580	1480	1395	1320	1250	1185	1130	1075	1025	960	900				
27,0	3,1 – 14,4 2000		2000	2000	2000	2000	2000	1930	1800	1685	1585	1495	1410	1340	1270	1210	1150	1100						
24,0	3,1 – 14,6 2000		2000	2000	2000	2000	2000	1975	1840	1725	1620	1530	1445	1370	1300									

Geschwindigkeiten Speeds / Vitesses

	U/min 0 – 1,0 sl./min tr./mn	2,2 kW
	20,0 / 40,0 m/min	1,3 / 2,3 kW
	25,0 m/min	2 × 1,3 kW
	0 – 45° ca. 30 sec.	3,0 kW

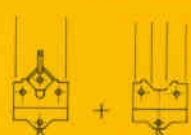
Hubwerk Hoist unit Mécanisme de levage	Stufe Step Cran	kg	m/min
	1	2000	6,0
	2	2000	25,0
	3	1000	50,0
	1	1750 3500	6,0 3,0
	2	1750 3500	25,0 12,5
	3	1000 2000	50,0 25,0

Kabelquerschnitt bei 380 V bis 28,0 m 4 × 10 mm² Betriebsspannung 380 V Frequenz 50 Hz Gesamtmotorenleistung max. 18,1 kW / 22,6 kVA
 Cross section of cable up to Operating voltage Frequency Total motor output
 Section de câble à Tension de service Fréquence Puissance totale des moteurs

Technische Kenngröße nach BGL Technische Kenngröße nach BGL Technische Kenngröße nach BGL
 Technical nominal size according to the construction machinery list (BGL) Technical nominal size according to the construction machinery list (BGL) Technical nominal size according to the construction machinery list (BGL)
 Grandeur caractéristique suivant le barème d'emploi des appareils (BGL) Grandeur caractéristique suivant le barème d'emploi des appareils (BGL) Grandeur caractéristique suivant le barème d'emploi des appareils (BGL)

 2108-0035  +  2108-0035

Technische Daten - Technical data Caractéristiques techniques

Aufstellvorgang

Erection procedure

Déroulement de montage

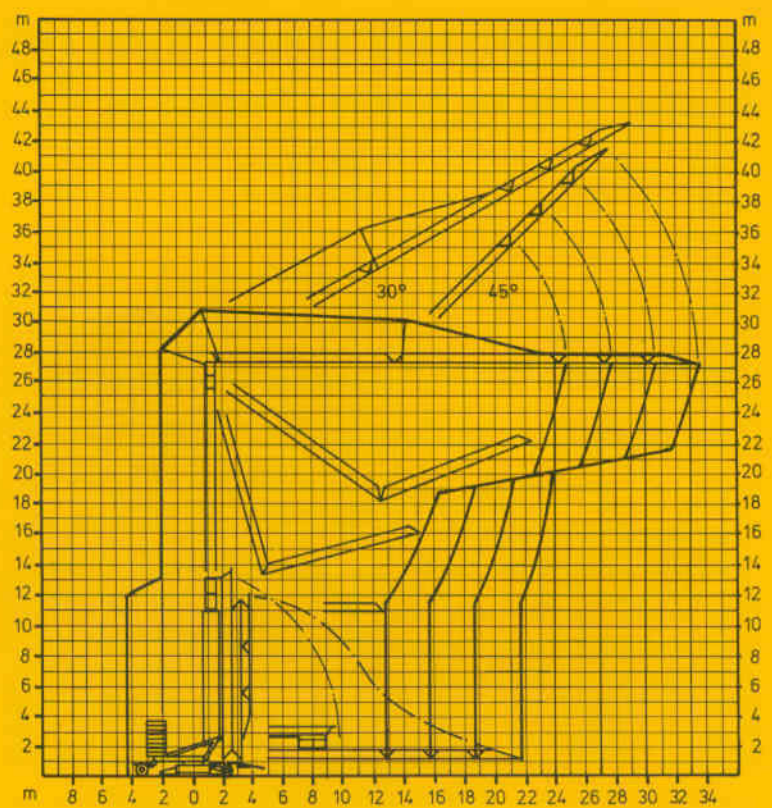









Ballasterausladung 5,0 m
Ballasting radius 5,0 m
Portée pour dispositif de lestage 5,0 m

Kolli-Liste

Packing list

Liste de colisage

Pos. Item Rep.	Anzahl Quantity Qté.	Benennung Description Désignation	Länge m Length m Longueur m	Breite m Width m Largeur m	Höhe m Height m Hauteur m	Einzelgew. kg Unit weight kg Poids unitaire kg	Gesamtgew. kg Total weight kg Poids total kg	
1	3	Turmstück Tower section Élément de mât		2,10	0,85	0,88	350	1050
2	1	Ausleger-Verlängerung 24,0 m – 27,0 m Jib extension Rallonge de la flèche		3,20	0,80	0,70		104
3	1	Ausleger-Verlängerung 27,0 m – 30,0 m Jib extension Rallonge de la flèche		3,10	0,80	0,70		97
4	1	Ausleger-Verlängerung 30,0 m – 33,0 m Jib extension Rallonge de la flèche		3,10	0,80	0,70		83
5	1	Transportachse vorne Tra 50 KW 1 Road transport axle front Essieux de transport avant		3,10	1,42	0,98		465
6	1	Transportachse vorne Tra 100 KY 1 Road transport axle front Essieux de transport avant		3,00	1,13	0,97		660
7	1	Transportachse hinten Tra 120 GY 1 Road transport axle behind Essieux de transport arrière		1,90	2,50	1,05		1150
8	1	Transportachse Tra 200 GZ 3 Road transport axle Essieux de transport		3,10	2,50	1,10		2600
9	1	Kiste mit Seilen und Kleinteilen Case with ropes and small parts Caisse avec câbles et pièces détachées		1,00	0,80	1,00		450

Datenblatt Nr. 120 P – 2455 – H 1 DIN 15018 und OENORM T 3 – 6. 85

Data sheet

Feuille de caractéristiques

Konstruktionsänderungen vorbehalten!

Subject to alterations!

Sous réserves de modifications!

Printed in Austria

Nehmen Sie Kontakt auf mit
Contact

Mettez-vous en rapport avec

LIEBHERR-WERK BIBERACH GMBH, Postfach 1663, D-7950 Biberach an der Riss 1,

Telefon (07351) 41-0, Telex 71802