

Untendreher

CM 90S4

Hydraulischer Schnellmontagekran
hydraulic fast-erecting crane

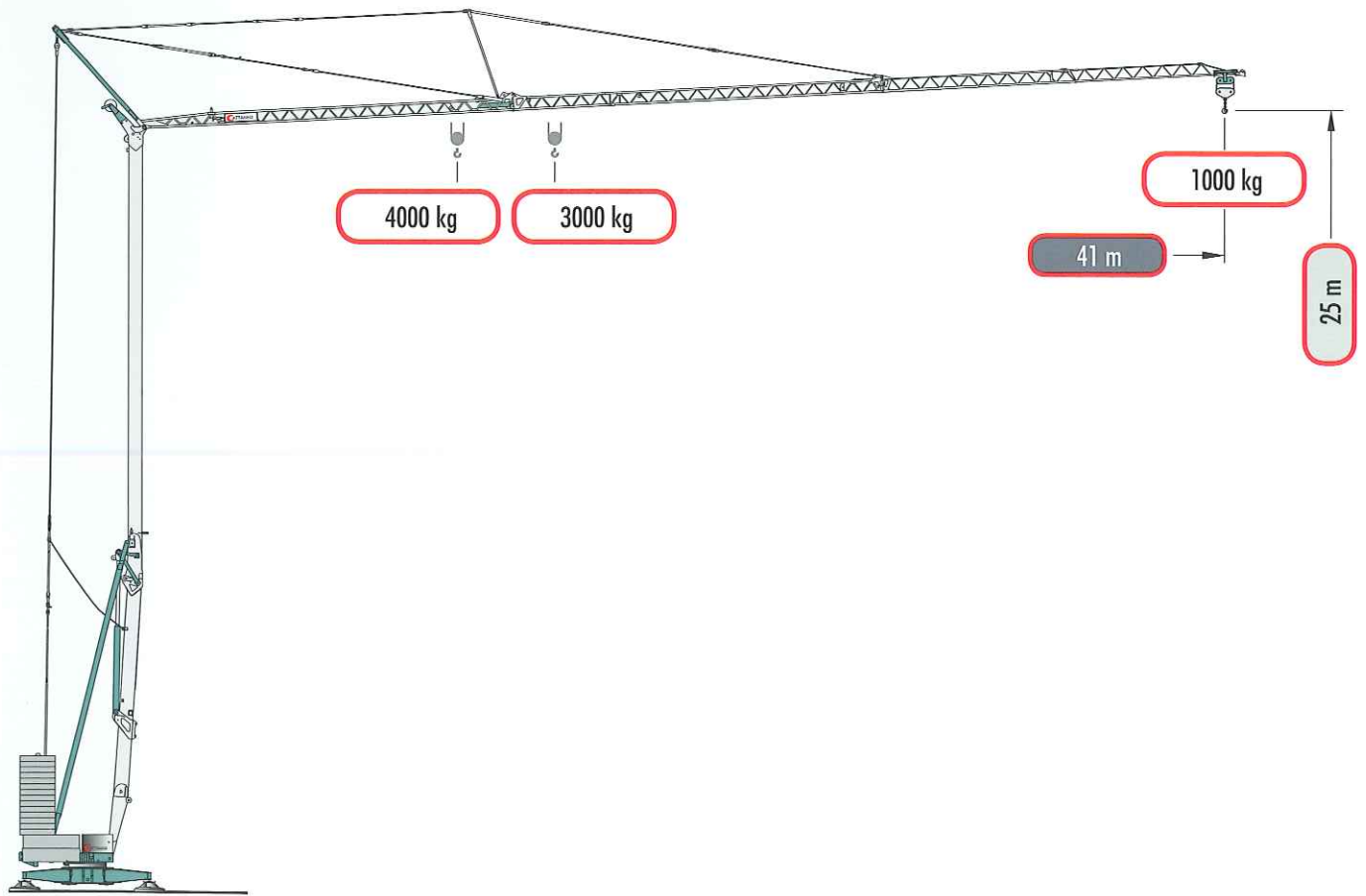

CATTANEO

CE 

EN 14439 C25

DIN 15018-H1/B3

Planung und Konstruktion ■ design and construction: Luigi Cattaneo S.p.A.

Untendreher

CATTANEO CM 90S4



Keine Elektrokomponenten am Ausleger und im oberen Bereich des Krans
No electrical components on the jib and on the top of the crane

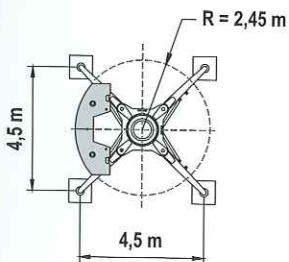
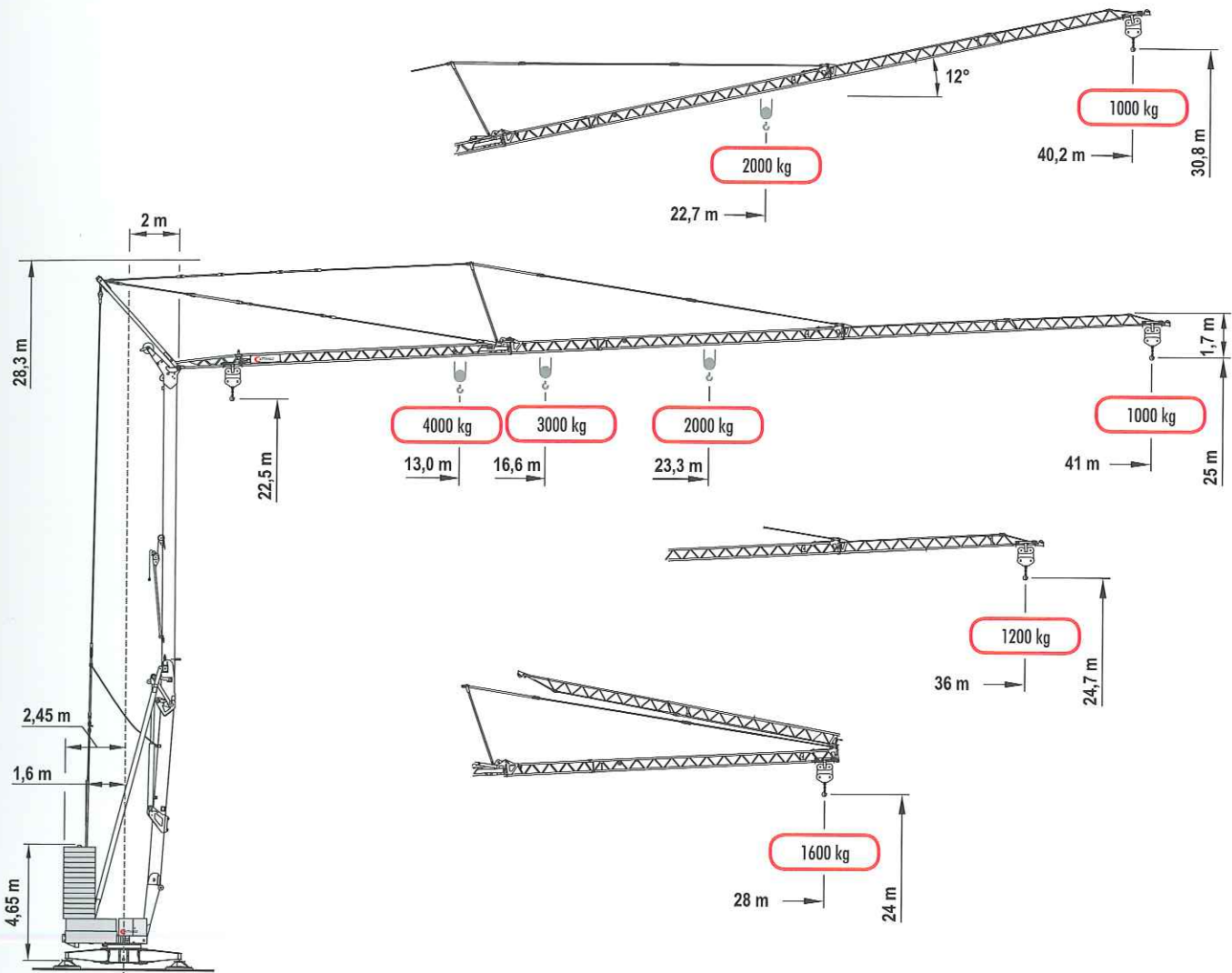

Max. kg 4000









Lastkurven Load diagrams

kg	4000	3000	2500	2000	1900	1800	1700	1600	1500	1400	1300	1200	1100	1000
m	13.0	16.6	19.3	23.3	24.2	25.3	26.5	27.9	29.4	31.1	33.1	35.5	37.8	41.0
m	13.1	16.9	19.6	23.6	24.6	25.8	27.0	28.4	30.0	31.7	33.7	36.0		
m	13.0	16.6	19.4	23.3	24.3	25.4	26.6	28.0						
m				22.7	23.7	24.8	26.0	27.4	28.8	30.5	32.4	34.6	37.0	40.2

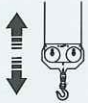
Konstruktionsänderungen vorbehalten ■ subject to alterations
Sämtliche Angaben erfolgen ohne Gewähr. ■ This information is supplied without liability.

CATTANEO CM 90S4

Leistung ■ performance

		kW		400V - 50Hz	21 kW
		kW/g/min		m/min	1° 2° 3° 4°
		18,5/1400		kg	4 20 35 50
		3/1400		m/min	10 - 25 - 50
		3,7/900		g/min	0,2 - 0,5 - 0,9

inverter: Frequenzumrichter (FU) ■ frequency converter

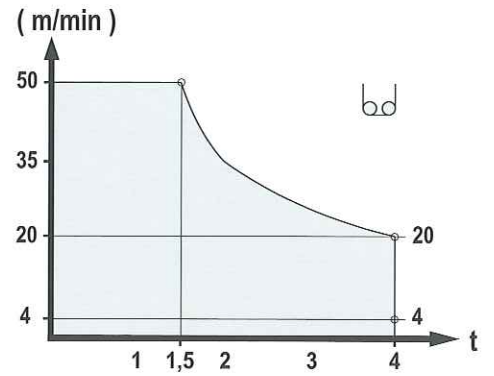

Montage ■ crane erection

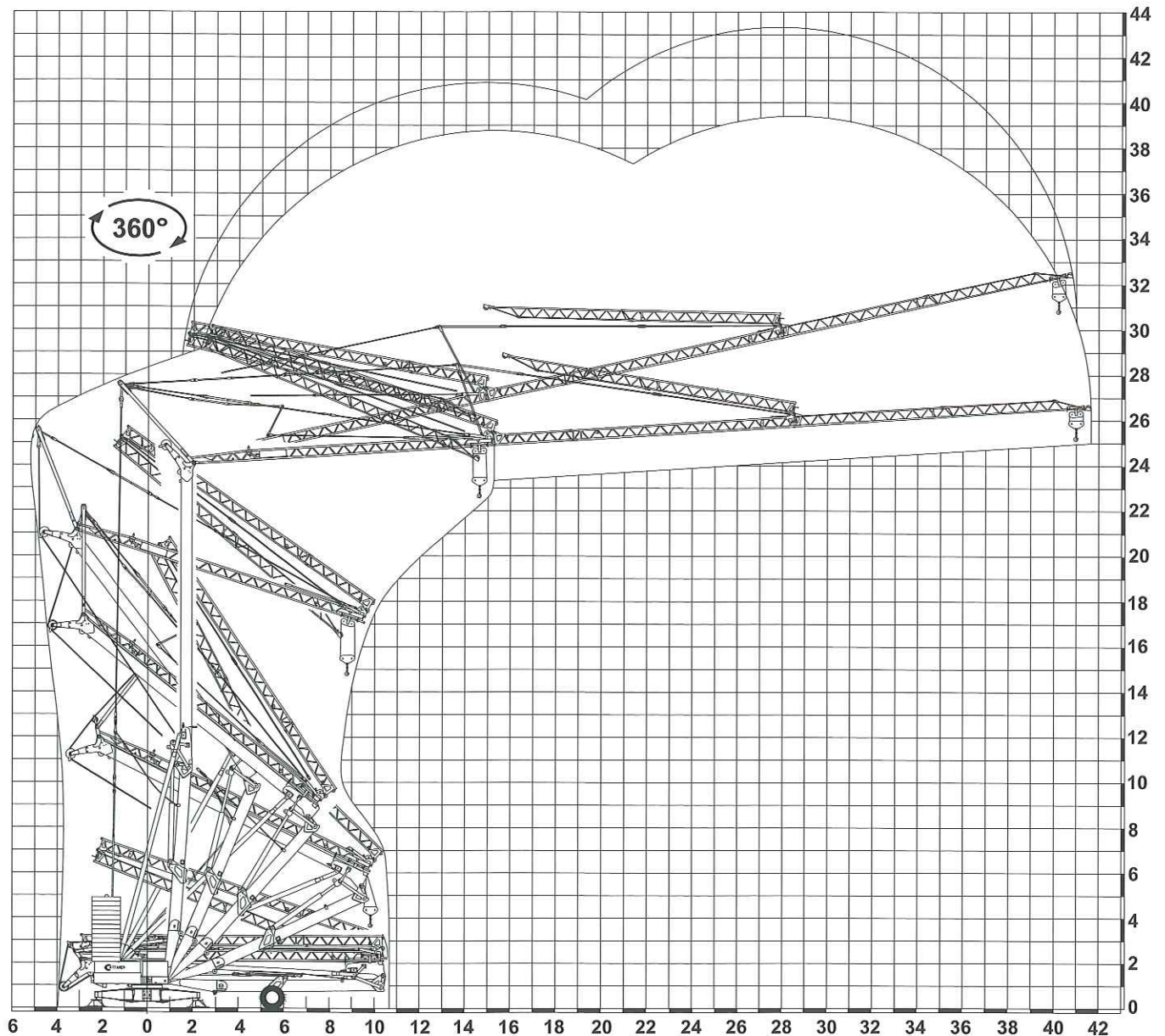

CATTANEO CM 90S4

Gegengewicht aus Betonplatten ■ concrete counterballast

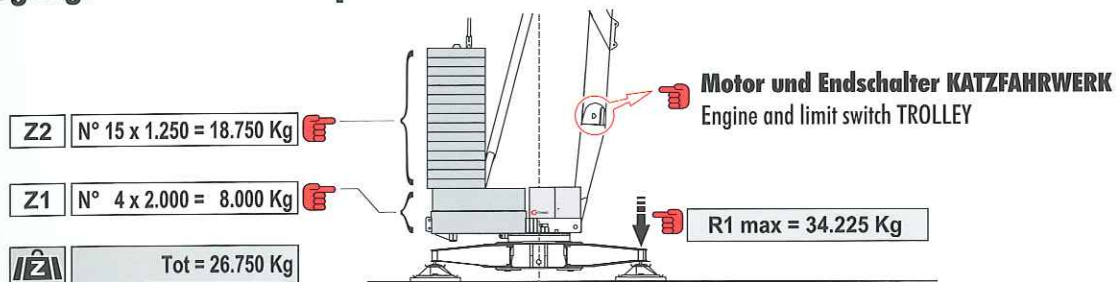

Transport ■ transport

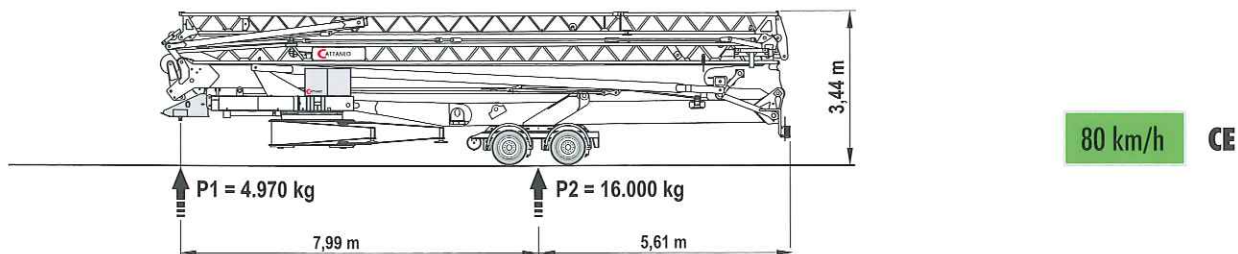
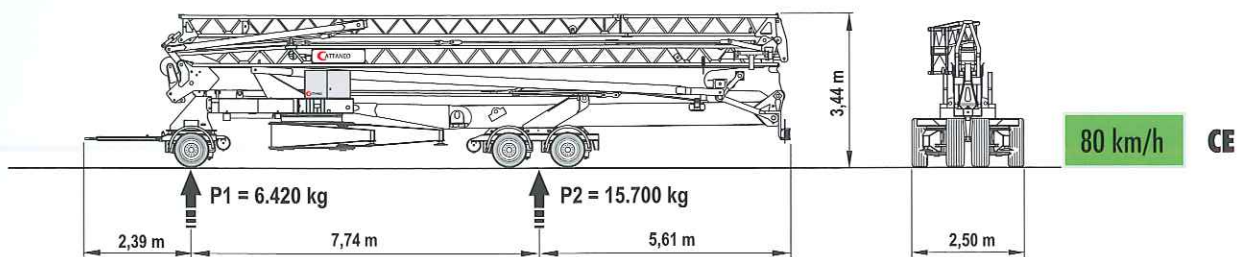
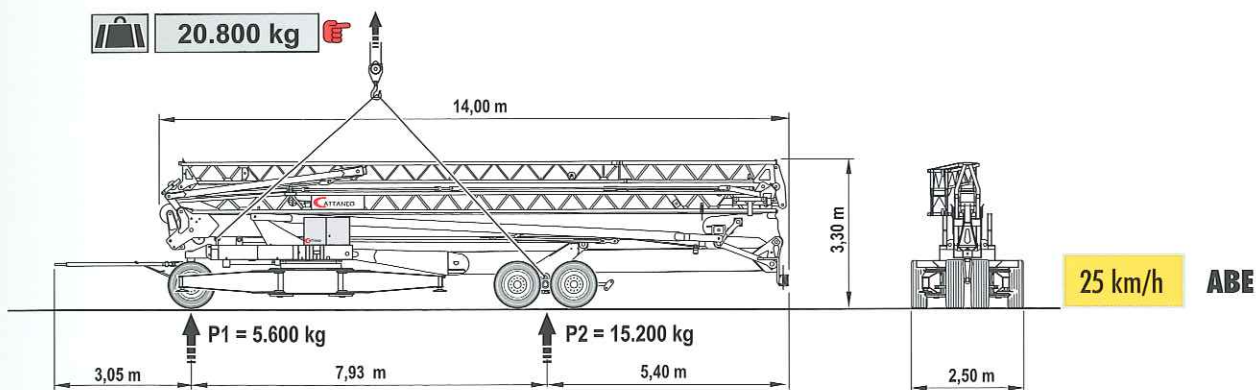

Ihr Händler ■ your dealer:



www.kwitek-krane.de