

Untendreher

CM 371

Hydraulischer Schnellmontagekran

hydraulic fast-erecting crane

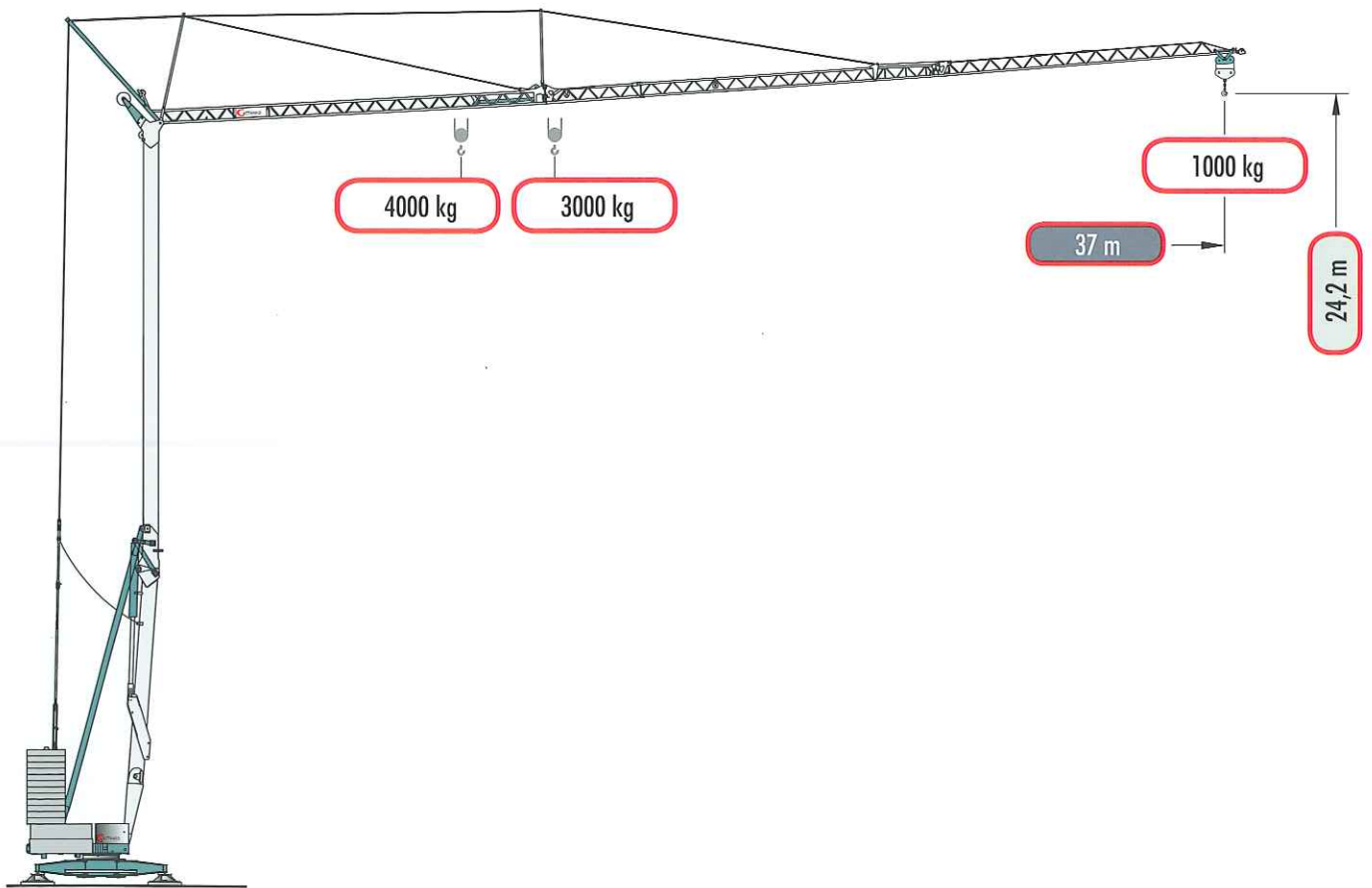

CATTANEO

CE  **96 dB**

EN 14439 C25

DIN 15018-H1/B3

Planung und Konstruktion ■ design and construction: Luigi Cattaneo S.p.A.

Untendreher

CATTANEO CM 371

Keine Elektrokomponenten am Ausleger und im oberen Bereich des Krans
 No electrical components on the jib and on the top of the crane

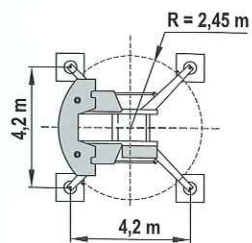
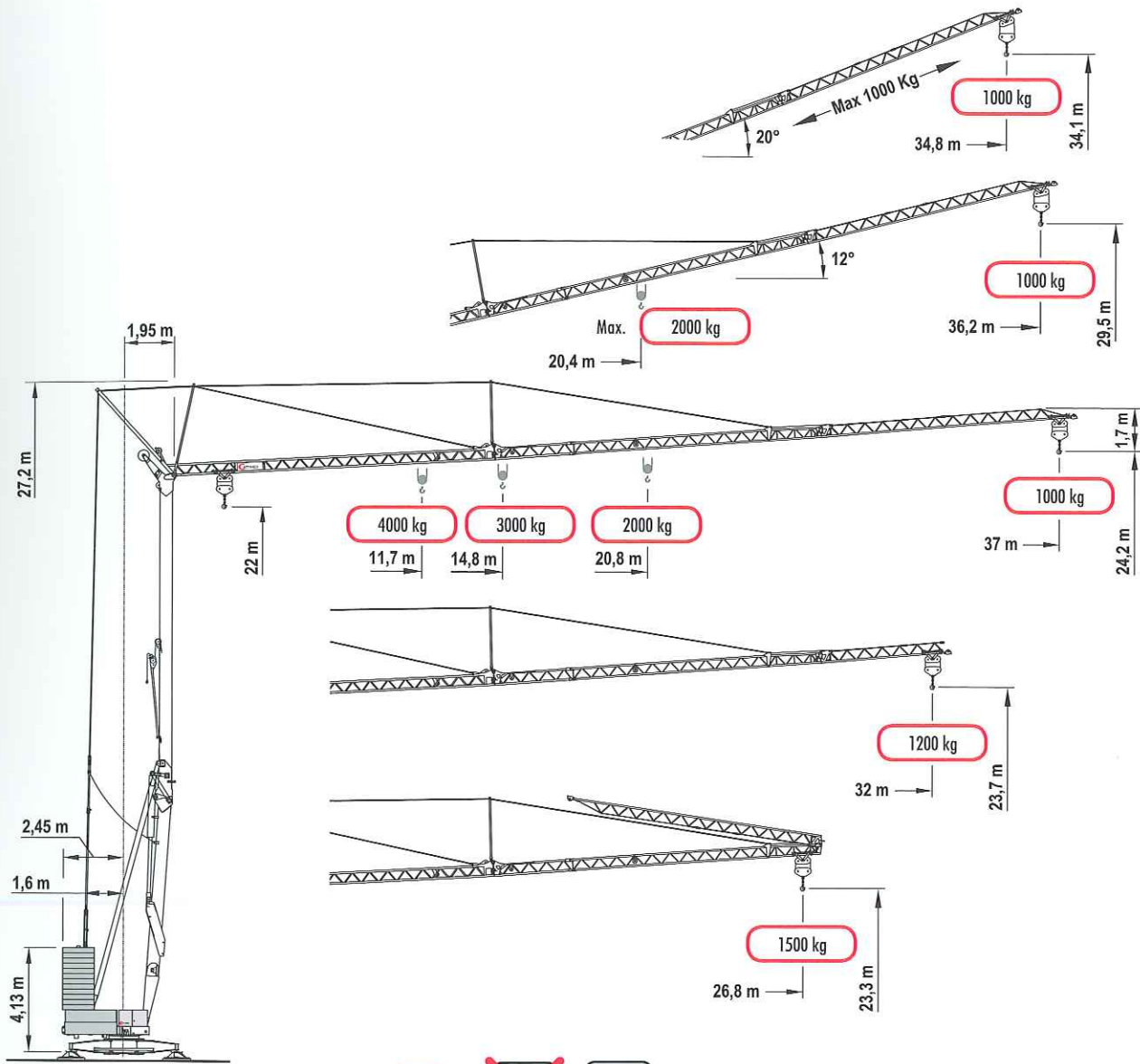

Max. kg 4000







Lastkurven Load diagrams

kg	4000	3000	2500	2000	1900	1800	1700	1600	1500	1400	1300	1200	1100	1000
m	11.7	14.8	17.3	20.8	21.7	23.7	23.9	25.1	26.4	28.0	29.8	31.8	34.2	37.0
m	11.8	14.9	17.4	20.9	21.9	22.9	24.0	25.2	26.6	28.2	29.9	32.0		
m	11.9	15.0	17.5	21.1	22.0	23.0	24.1	25.4	26.8					
m				20.4	21.3	22.3	23.4	24.6	26.0	27.5	29.2	31.2	33.5	36.2

Konstruktionsänderungen vorbehalten ■ subject to alterations
 Sämtliche Angaben erfolgen ohne Gewähr. ■ This information is supplied without liability.

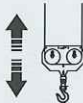
CATTANEO CM 371

Leistung ■ performance

		kW	 400V - 50Hz				21 kW				
	inverter	kW/g/min		m/min		1°	2°	3°	4°		
		18,5/1400		4	20	35	50				
	inverter	3/1400	m/min		10 - 25 - 50						
	inverter	3,7/900	g/min		0,2 - 0,5 - 0,9						

inverter: Frequenzumrichter (FU) ■ frequency converter

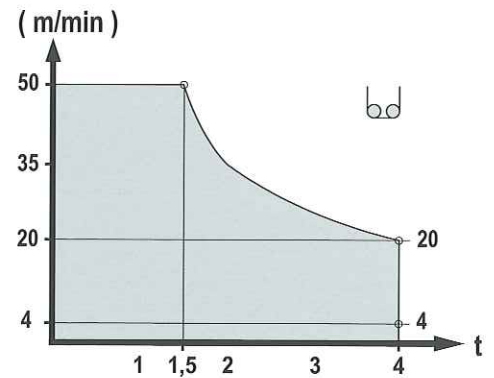

Montage ■ crane erection

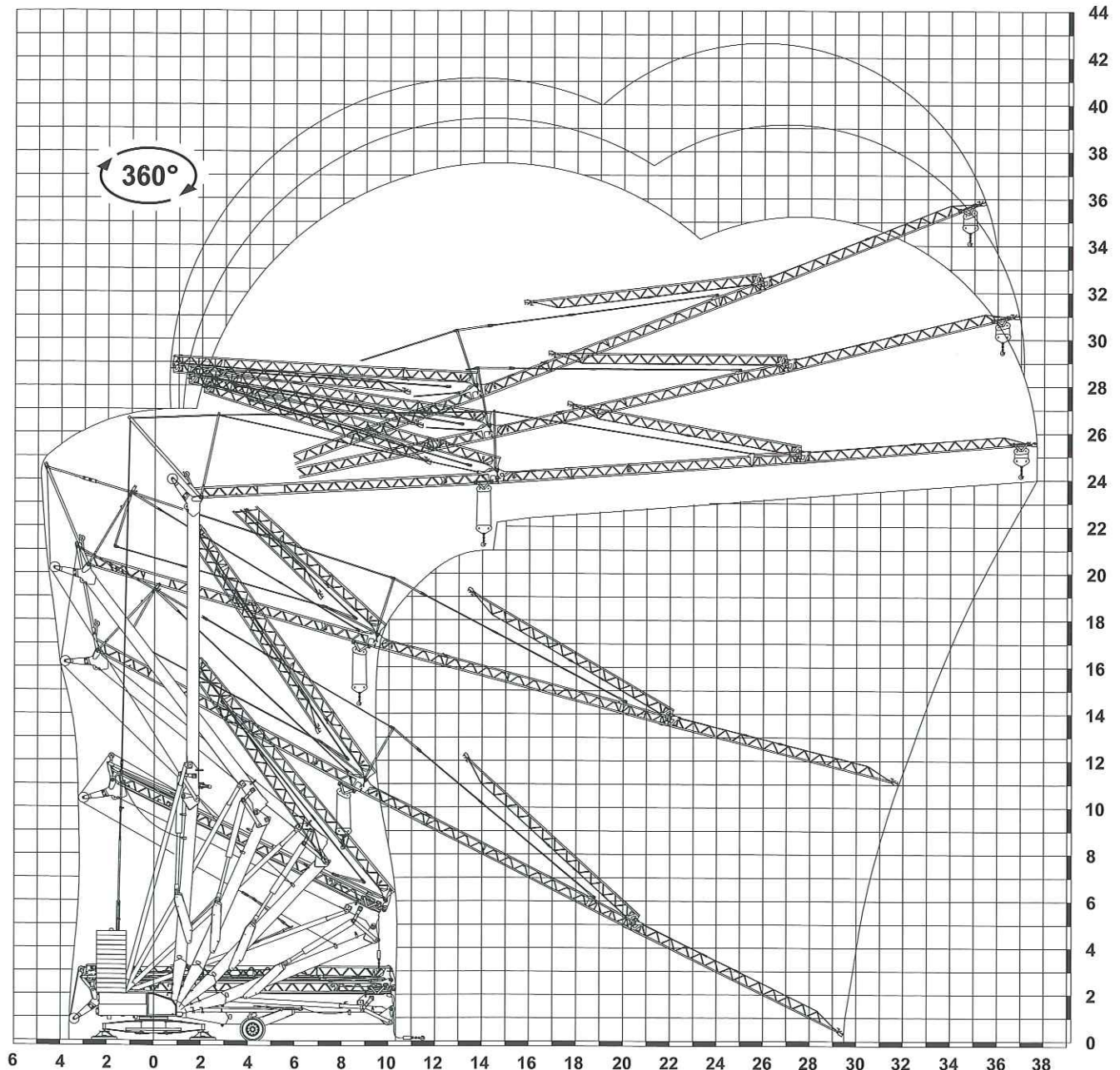

CATTANEO CM 371

Gegengewicht aus Betonplatten ■ concrete counterballast

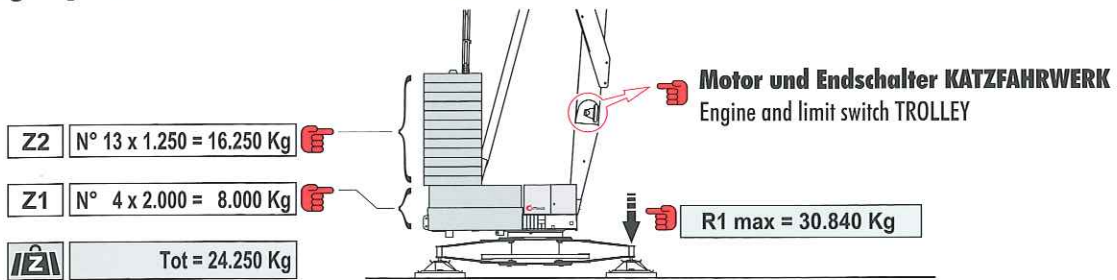

Transport ■ transport

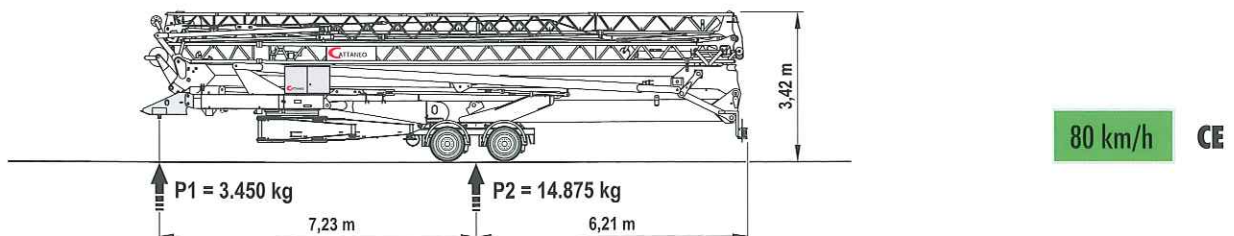
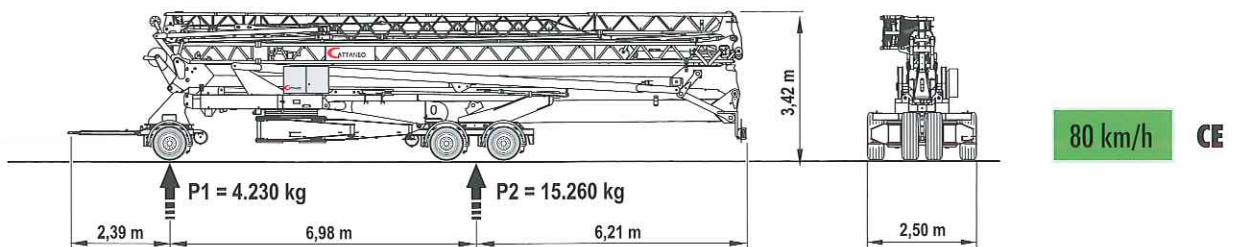
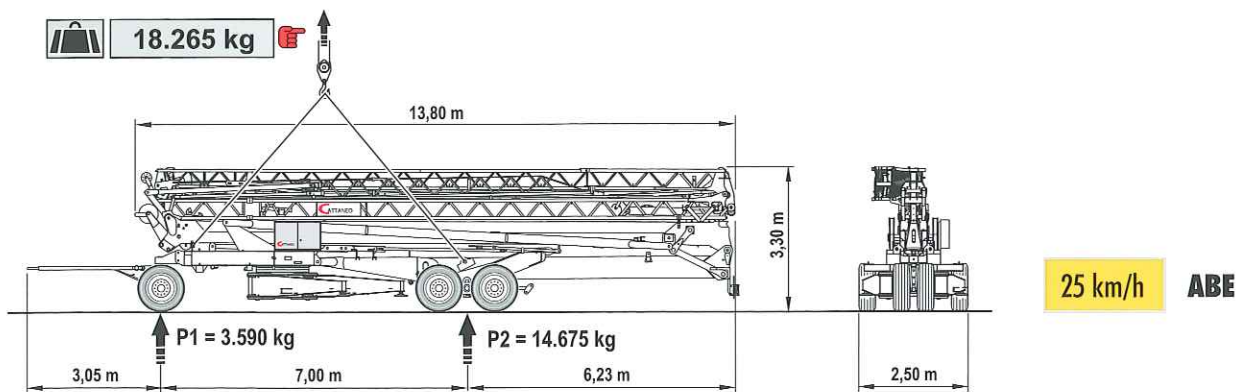

Ihr Händler ■ your dealer:



www.kwitek-krane.de